

**GAS**  
AUDIO POWER

**MAX USER MANUAL**



# MAX K2

K2-64

**HARDCORE CAR AUDIO**

## **WE PLAY LOUD!!**

We know what you want. You want it LOUD, and that is exactly what we do, what we live for. Vibrations, gut-punches and straight up loud music - that's what makes us tick. We won't dress up in fancy words or claim to be something we're not. We are the NO BULLSH!T car audio brand!











Every single product with the GAS logo on it is born out of passion, the same that has driven us for two generations and that will keep us rolling up to your neighbourhood, winning and pushing the limits for many generations to come!

It's up to you to choose your own level of loud, and if you don't like what we do that's OK. You are welcome back when you've had your first true GAS experience. We don't exclude, we don't judge and we do not make up any excuses for who we are.

We are GAS and we are proud to be LOUD!

# **GAS**

# TABLE OF CONTENT

 SAFETY.....	3
 UNPACKING.....	4
 DIMENSIONS.....	4
 SPECIFICATIONS.....	6
MAX K2-64.....	6
 PERFORMANCE.....	8
Impedance vs Frequency.....	8
 FEATURES.....	9
The sum of awesome.....	9
Next level water resistance.....	9
When “good” isn’t good enough.....	9
Easy to install.....	9
Hear the difference.....	9
 HOW TO.....	10
Install component kit.....	10
Speaker & tweeter placement.....	12
Crossover phase function.....	13
 TROUBLESHOOTING.....	14
No power/sound.....	14
Unwanted noise.....	14
Distortion.....	14
 WARRANTY & DISPOSAL .....	15
 THE GAS WORLD.....	16



# SAFETY

**PLAY LOUD & SAFE.** Read through this information, follow the instructions and save the manual for future usage and reference.

Make sure to pay attention to the instructions when you see this symbol: 

Do not expose the wiring to your new speaker to excessive damp or moisture. If the speaker's wiring is exposed it might result in electric failure, shock or damage to the product. Servicing is required when the product has been damaged in any way and/or doesn't operate normally. Refer all servicing to qualified service personnel only.

Keep the cables inside the vehicle separate from sharp edges or components that may be affected or take damage. Follow the recommended cable sizes and always use high quality cables and accessories. Even if you're eager to put the speakers to use – take no shortcuts when installing the cables, make sure that all connectors are protected and secured.

Do not drill any holes without checking what lies beneath, and don't cut anything without making sure that no important components risk being damaged.

There is a first time for everything, if you need help - ask a friend or contact your local GAS AUDIO POWER dealer/installer.

We want you to experience your product's MAD sound, but we don't want you to injure yourself or others. Use common sense, respect high pressure levels and volume, and follow your local laws and regulations.



# UNPACKING

Unboxing your new MAX product is an experience, make sure that the speakers and all the accessories are included in the packaging:

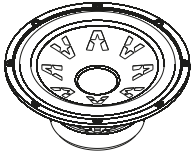

Speakers  
(2pcs)

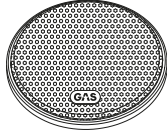

Grills  
(2pcs)

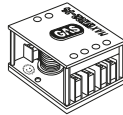

WF Crossovers  
(2pcs)

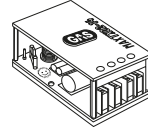

TW Crossovers  
(2pcs)



Manual  
(1pc)



Tweeters  
(2pcs)

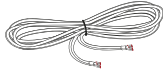

Crossover cables  
(4pcs)

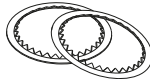

TW Mounting rings  
(2pcs)



Glue pads  
(2pcs)

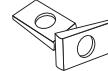

V-type clips  
(8pcs)



Screws  
(16pcs)

# DIMENSIONS

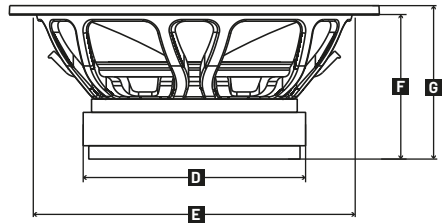
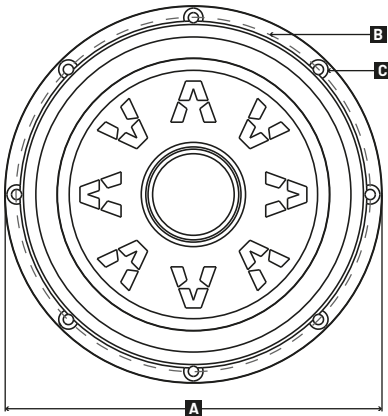

	A	B	C	D	E	F	G	
MW2-64	166	Ø156	Ø4.5	100	142	65	69	mm

# DIMENSIONS

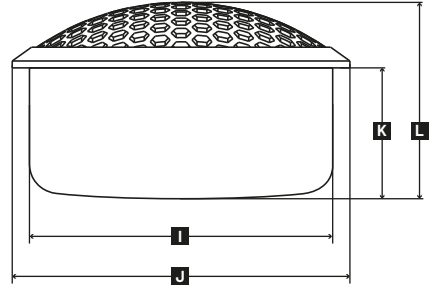
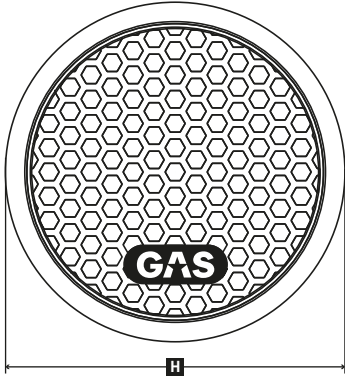

	H	I	J	K	L	
<b>T2-254</b>	Ø49	Ø44	Ø49	19	26	<b>mm</b>

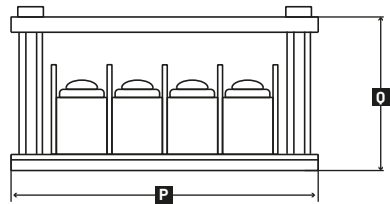
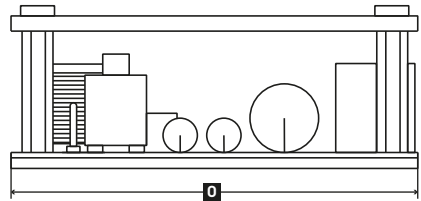
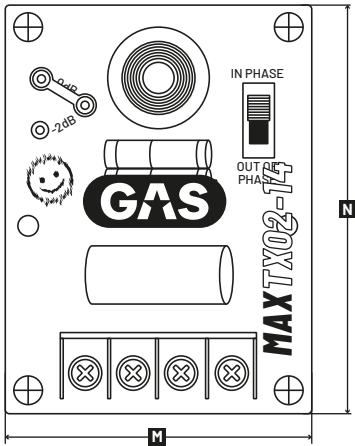

	M	N	O	P	Q	
<b>TX02-14</b>	60	80	80	60	30	<b>mm</b>
<b>WX02-14</b>	60	60	60	60	30	<b>mm</b>



# SPECIFICATIONS

Below you'll find the specifications that has been checked and tested in our workshop. The specified sensitivity isn't directly connected with the sound pressure in the vehicle, and shouldn't be used as the sole indicator for comparison with other component kits.

## MAX K2-64

Component	Component kit
Woofer size	6.5" (165mm)
Tweeter size	1" (25mm)
Nominal impedance	4 Ohm
Power RMS	130W
Power MAX	260W
Freq. response	55-23 000Hz
Sensitivity	93dB

## MAX T2-254 TWEETER

Tweeter size	1" (25mm)
Nominal impedance	4 Ohm
Power RMS	65W
Power MAX	130W
Freq. response	2000-23 000Hz
Sensitivity	93dB
Tweeter dome	silk
Tweeter magnet	Neodymium
Fs	880Hz

## MAX MW2-64 WOOFER

Woofer size	6.5" (165mm )
Nominal impedance	4 Ohm
Power RMS	130W
Power MAX	260W
Freq. response	55-7000Hz
Sensitivity	93dB
Woofer cone	A3D WRC Paper
Woofer basket	Aluminum
Woofer suspension	NBR Rubber
Woofer magnet	HQ Ferrite
Woofer spider	Polycotton/Nomex
Voice coil	1" (25mm ) ASV
Voice coil wire	Copper
Shorting ring	Yes/Copper
Terminal	S2 screw/spade

### THIELE/SMALL PARAMETERS

Fs	59.1Hz	Qms	3.48
Vas	15.5L	Re	2.8 Ohm
Qts	0.46	Mms	10.6g
Qes	0.52	Bl	4.7Tm

# SPECIFICATIONS

## **MAX WX02-14 CROSSOVER**

Crossover type	Low pass
Slope	6db
Cut off	4500Hz

## **MAX TX02-14 CROSSOVER**

Crossover type	High pass
Slope	12db
Cut off	4500Hz
Tweeter level	High / Low
Phase selector	Yes



# PERFORMANCE

## IMPEDANCE VS FREQUENCY

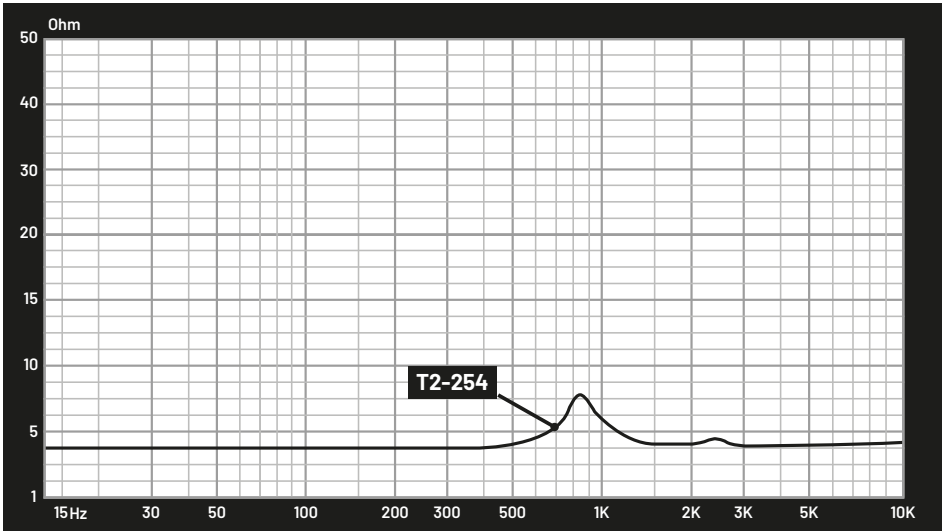
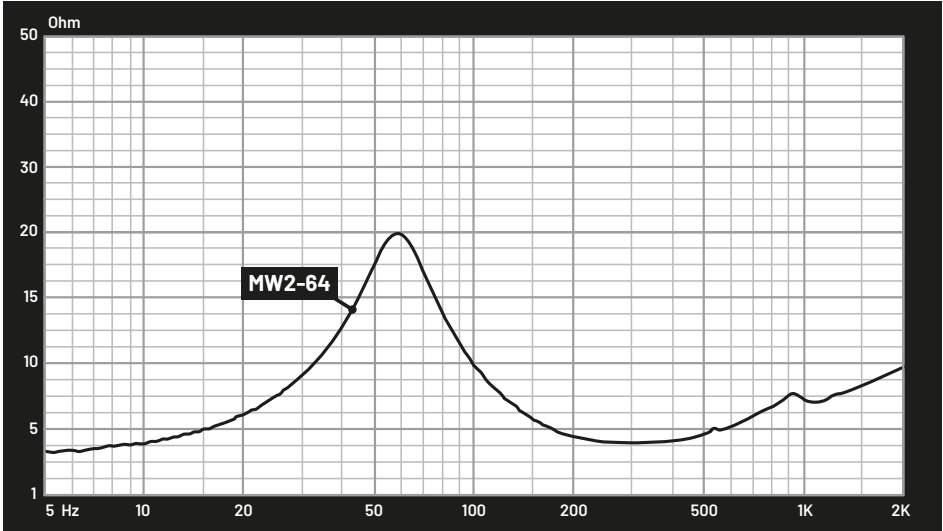

# FEATURES

If you have this in your hand, you've finally made it. Congratulations! You're ready to take the next step, to enter a world of NO COMPROMISES with a component kit that will take your car to a whole new level. So get out there and impress the non-believers! Show them that true dedication comes from the inside of your car and that "good enough" just doesn't cut it.

## THE SUM OF AWESOME

With a high-quality ferrite motor, copper wire voice coil, aluminum former, and copper shorting ring, the GAS MAX K2-64 has a strong and stable foundation for the speaker. It ensures that the speaker can deliver crisp, clear, and powerful audio that exceeds your expectations. But we didn't stop there. The MAX series is all about quality, which is why we used an aluminum basket and metal tweeter housing. This speaker is built to handle anything you throw at it, rough and tough conditions are not an issue, thanks to the DVS ventilated basket and back plate with the beautiful GAS A Star pattern.

## NEXT LEVEL WEATHER RESISTANCE

Sweden, where the GAS speakers are designed, is known for its harsh climate. It's cold, warm, wet, windy - we got it all, and on any given day you might even experience them all at the same time. Just for this reason the MAX K2-64 features an A3D Lightweight pressed paper cone with WRC (Water Repellent Coating). This cone is strong, with high sensitivity and of course totally weather resistant. This means that you can enjoy your music, no matter the climate or weather.

## WHEN "GOOD" ISN'T GOOD ENOUGH

The GAS MAX K2-64 kit also features a low Fs design midwoofer, which reproduces not only the midrange spectrum but also the vital midwoofer experience with great authority and dynamics. The NBR suspension & Polycotton/Nomex spider provides impressive detailed and responsive sound reproduction, and the silk dome tweeter delivers clear and brilliant highs without getting harsh. In other words, you'll be able to hear every detail, making your favorite music sound bolder and more lifelike.

## EASY TO INSTALL

To give you better and easier mounting options, we've also included separate crossovers. You can even choose between passive or active use of the tweeter and midwoofer. The speaker comes with the beloved S2 Crosshead terminal, which allows you to choose either the flat pin connector or connect with a crosshead screw, giving you the best of both worlds.

## HEAR THE DIFFERENCE

Finally, the speakers come included with hexagon patterned grilles with an aluminum badge, which protects the speaker and keeps your build stylish. The aluminum badge adds a touch of elegance to your car audio system. Upgrade your car audio with the GAS MAX K2-64 component speaker and experience the sound difference (and quality) for yourself.

# HOW TO

## INSTALL COMPONENT KIT

Before installing your brand new component kit, make sure that you have everything you need. Have the right tools ready, and make sure that you have the necessary knowledge/skill to perform the installation properly. Preparation and knowledge is crucial!

The component kit includes three main parts: the midrange woofers, the tweeters and dual crossovers. The crossovers should be wired before the midrange woofer and the tweeter. They make sure that the woofer and tweeter plays on the right part of the LOUD spectrum.

### STANDARD CONNECTION WITH CONNECTED CROSSEVERS:

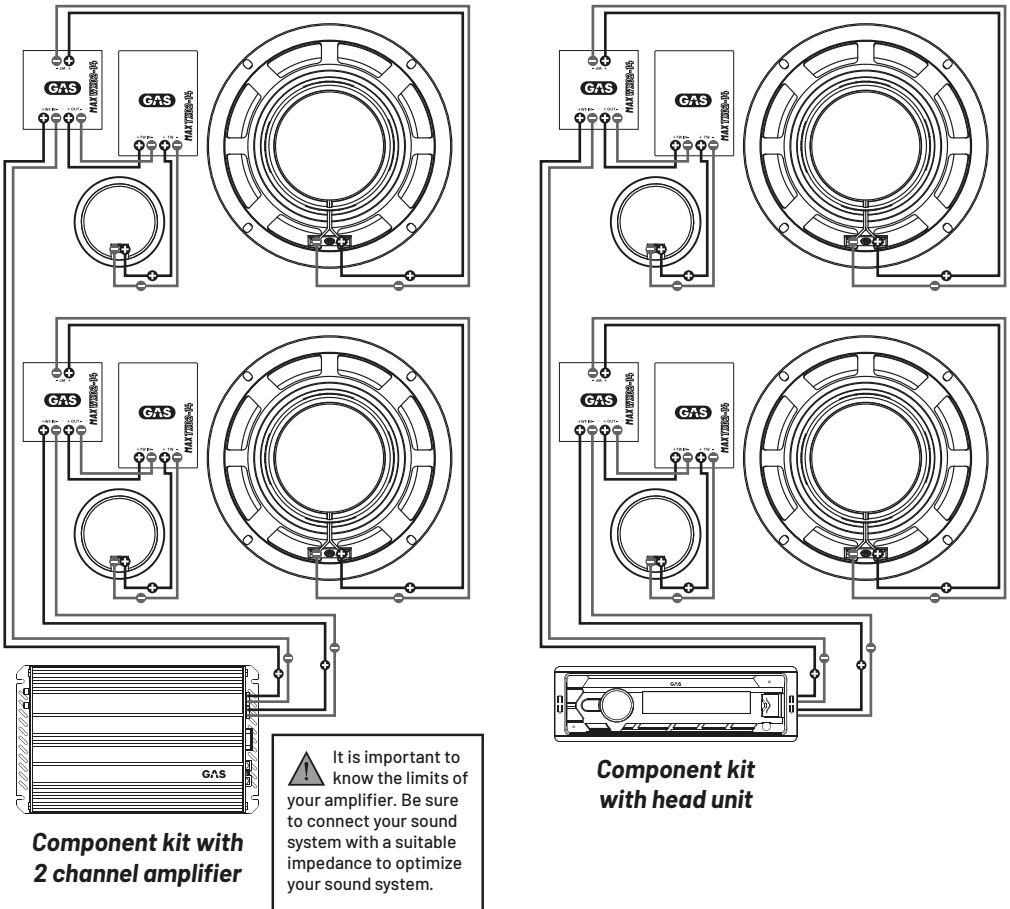

# HOW TO

## BI-AMP CONNECTION WITH SEPARATED CROSSOVERS:

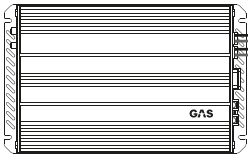

**Component kit with 2x2 channels amp.**

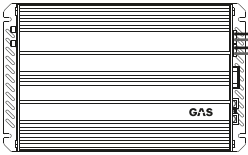

**Component kit with 4 channel amplifier**

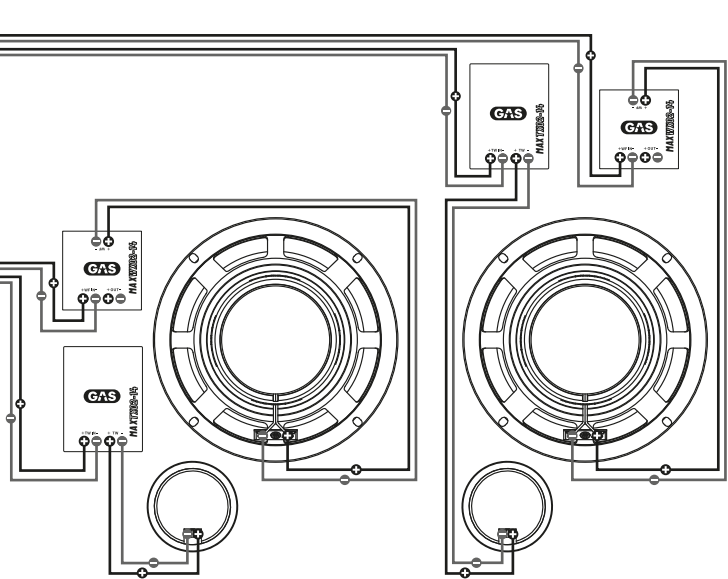

**⚠** It is important to know the limits of your amplifier. Be sure to connect your sound system with a suitable impedance to optimize your sound system.

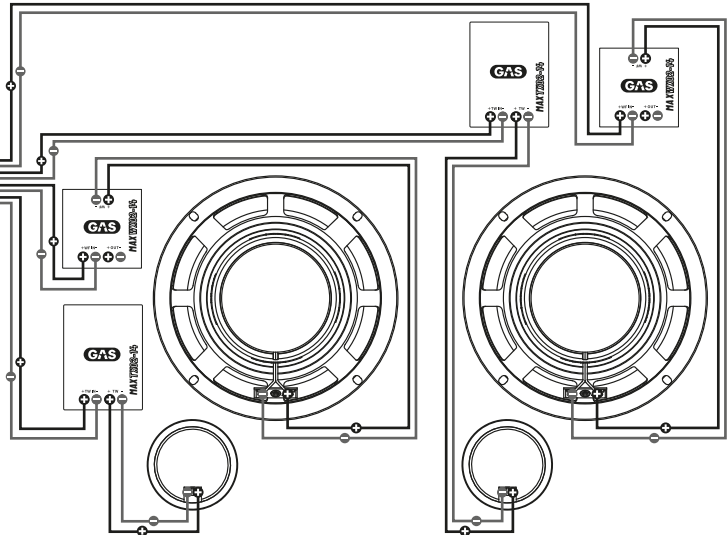

# HOW TO

## SPEAKER & TWEETER PLACEMENT

Now that you know how to connect your component kit, you need to decide where to put it. You will most likely have one or two possible locations to put the speakers and tweeters depending on make and model. This is where the fun begins!

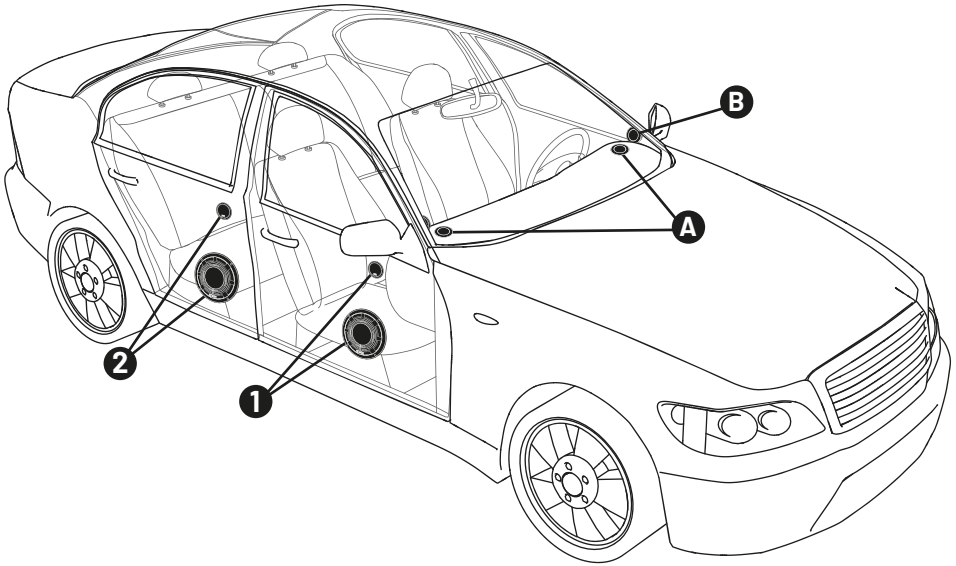

### 1) FRONT DOORS

The front right and left doors are typical positions for woofer placement! In some models you'll find original speakers in the kickpanel - right in front of the doors in the footwell.

### 2) BACK DOORS

Some car models out there have a 2-way system in the back. If your car's on the more luxurious side of the spectrum, you might find a component kit in both the front and rear.

### A) DASH

The tweeter is usually placed here. Do you see a small grille around the left and right end of the dash? Awesome! Put your new tweeter here. If your car's a bit older, you might not have a tweeter in your dash to begin with.

### B) A-pillar

In some cars, the tweeter is located in the A-pillar. Lucky you! This is a great location to put a tweeter, since it's placed higher up and directly aimed at your ears.

# HOW TO

## CROSSOVER FUNCTIONS

The two crossover models included with the K2-64 speakers are made to give you a maximized sound experience! The crossovers consist of one separate high pass and one low pass filter for each L/R channel. MAX TX02-14 is a 12db tweeter high pass filter with phase and level settings. MAX WX02-14 is a 6db midwoofer low pass filter. There are several options to connect the crossovers with both passive and active set-ups (see pages 9 & 10 for wiring schematics).

### MAX TX02-14 CROSSOVER:

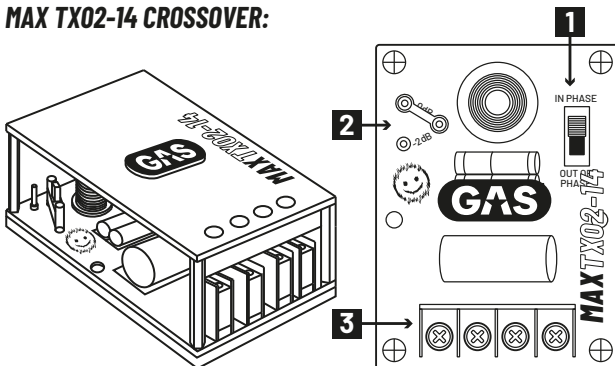

**1 PHASE SWITCH 0/180**  
Depending on placement, the phase might need to be shifted between midwoofer and tweeter. The switch helps you determine correct system settings without the need to change polarity of the cables at the terminal.

**2 TWEETER LEVEL SETTING**  
Adjust the tweeter level setting between 0dB or -2dB to affect the volume. Use -2db for LOUD, or the 0dB setting for LOUDER!

**3 TERMINAL PORTS**  
Input terminal for amplifier (left ports) and output terminal for tweeter (right ports).

**HINT!** The correct phase for your setup will always play LOUDER and give you more presence. This is the two main improvements to listen for when setting the phase switch correctly. If you are uncertain which is the best setting you can always leave the switch as factory default "in phase".

### MAX WX02-14 CROSSOVER:

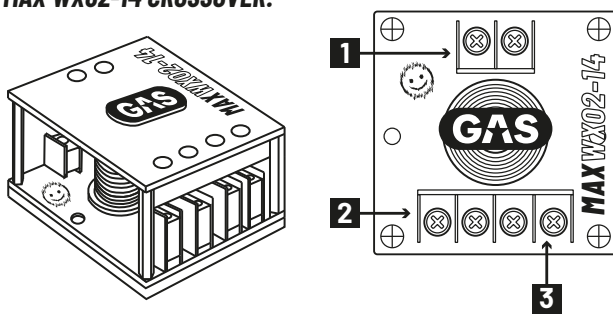

**1 WOOFER OUTPUT TERMINALS**  
Output terminal for woofer.

**2 WOOFER INPUT TERMINALS**  
Input terminal for amplifier (left ports).

**3 TWEETER OUTPUT TERMINALS**  
Output terminal for tweeter (right ports).

# TROUBLESHOOTING

## NO POWER/SOUND

Check the speakers to make sure they're not damaged. If your speakers don't get any power, the most common issue is either in the wiring or in the amplifier. Use a multimeter to measure the amplifier's voltage on the +12V terminal and the remote signal terminal. Use a multimeter to make sure that you have a negative ground connection. Check the built-in fuse (if there's one) on the amplifier. If there's no power coming through - control the fuse on the power cable. If it's intact - make a full check of the wiring to ensure cable integrity.

Check all the speakers connected to your sound system. Check all the speaker cables and all the signal cables. Check your head unit to make sure no settings are limiting the amplifier's functions or the speakers. When all of the above has been tested/looked over, and all is as it should be but there's still no sound, consult your local GAS AUDIO POWER dealer/installer.

## UNWANTED NOISE

Start by looking over the speakers in the sound system so there is no damage or connection issue with the wiring. Make sure that your signal cables or speaker cables aren't too close to the power cables. Check your amplifier's grounding point and make sure that the surface is clean. When all of the above has been tested/looked over, and the unwanted noise does not vanish, consult your local GAS AUDIO POWER dealer/installer.

## DISTORTION

Start by looking over the speakers in the sound system so there's no damage or connection issue with the wiring. Check the speaker cables to make sure that the polarity isn't reversed on one channel. Check the settings on the amplifier, make sure that the gain/level is set according to the amplifier's instructions. If your amplifier has a boost function, turn it down or turn it off.

# WARRANTY & DISPOSAL

This product is covered by warranty, depending on the conditions in the country where it's sold. If the speakers are returned for service, please include the original dated receipt (or a copy) with the product. Make sure that the speakers are packaged properly and secured, preferably in its original packaging.



The crossed-out wheeie bin symbol means that the product, literature and packaging included must be taken to separate collection at the end of their working life. Don't dispose of these products as unsorted municipal waste: take them for recycling. For info on your nearest recycling point, check with your local waste authority.



This product has been granted with the CE certification mark to show that the product follows the health, safety, and environmental protection standards for products sold within the European Economic Area (EEA).



GAS Audio Power products comply with the relevant provisions of the RoHS Directive for the European Union. In common with all Electrical and Electronic Equipment (EEE) the product shouldn't be disposed of as household waste. Alternative arrangements may apply in other jurisdictions.



GAS Audio Power is a global partner of the European Mobile Media Association, an organization that focus on promoting the custom made mobile media installations to consumers.



# THE GAS WORLD

You've entered the world of GAS. We aim to please, and we've made sure to have products made for you. No matter what stage of the LOUD-addiction you might find yourself in, there is a GAS product to fill your need.

## ***MAD***

Just starting out? The MAD series is made to play LOUD and to be the express lane to a no bullsh!t sound system that will make sure everyone can hear you coming!

## ***MAX***

The MAX series holds products made to deserve the center stage. Powerful, heavy duty and designed to be noticed. We made NO COMPROMISES because we know that you wouldn't accept it.

## ***CMP***

The CMP series has been developed for the crucial seconds when the dB-counter starts to tick. All CMP products have hand-picked, high quality, COMPETITION GRADE components and they are specially designed to withstand an awesome amount of power.



# THANKS FOR JOINING GAS AUDIO POWER!

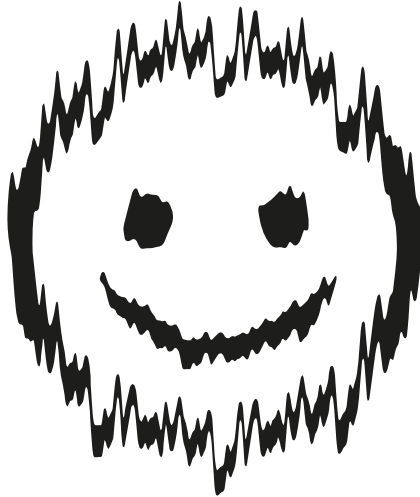

**GAS**  
**AUDIO POWER**

GAS AUDIO POWER and SHAKY are registered trademarks by Winn Scandinavia AB and is protected by relevant laws and jurisdictions such as Copyright and Trademark laws.

Winn Scandinavia AB | Elementvägen 15, 70227 Örebro, Sweden | [www.winnscandinavia.com](http://www.winnscandinavia.com)

Winn Scandinavia AB reserves for possible typos, factual or numeric errors that may have been printed on any products, package designs, user manuals and/or other included accessories.



**GAS**

**AUDIO POWER**